



KRYPTON S-131W

STAINLESS STEEL
HANDMADE SINGLE BOWL KITCHEN SINK



DIMENSIONS

31" x 19" x 9"

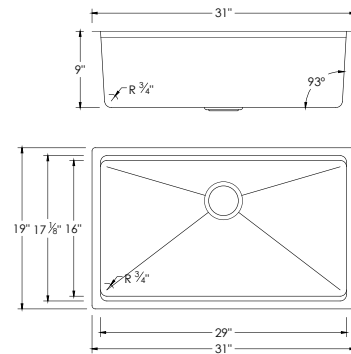

INCLUDED ACCESSORIES

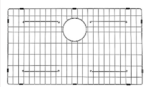

G-131
GRID



ST-05
STRAINER



A-06
COLANDER

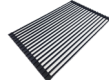

A-902BK
BLACK DRYING RACK



A-917
BLACK CUTTING BOARD

RECOMMENDED ACCESSORIES

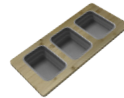

A-908
SERVING BOARD



A-912
CUTTING BOARD

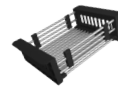

A-911
BASKET



A-916BK
DRYING MAT



S-01S
SOAP DISPENSER

SURFACE FINISH

BRUSHED
STAINLESS
STEEL

DRAIN HOLE SIZE



CORNER PROFILE



RADIUS 20mm

INSULATION

COATED +
RUBBER PADS

BOWL DEPTH



INSTALLATION OPTIONS



DROP-IN

UNDERMOUNT

MATERIAL

Premium 16 gauge stainless steel with 18/10 chrome-nickel content. The 18% of chrome content provides durability, maximum protection against rust and a beautiful satin finish. The 10% of nickel content provides excellent strength and hardness.



16 GAUGE
STAINLESS STEEL

PRODUCT DIMENSIONS

Overall Dimensions	31" x 19" x 9"
Internal Dimensions	29" x 17 1/8" x 9"
Left Basin	-
Right Basin	-
Drain Opening Size	3 1/2"

STANDARD STRAINERS

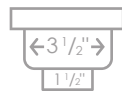

CABINET SIZE

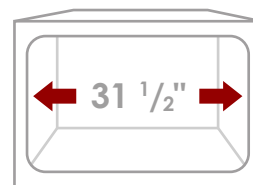

MINIMUM
INTERNAL SIZE

GARBAGE DISPOSAL

Stylish® sinks have on standard 3 1/2" drain opening that can fit any garbage disposal unit. The sink structure is well designed to withstand any heavy garbage disposal unit.



WARRANTY

This product is covered by a limited lifetime warranty. Consult our website for complete details.

PRODUCT CARE

Rinse and dry your sink with a clean soft cloth, working with, not a cross, the grain. We recommend the use of a mild solution of water and vinegar to remove any mineral deposits that may have built up on your sink.

Use mild non-abrasive liquid cream cleaners that do not contain chlorine, sodium hypochlorite or hydrochloric acid to help maintain the original appearance of your sink. Ensure that you thoroughly rinse your sink and wipe it dry. We recommend the use of a stainless steel grid that fits inside the bottom of the sink bowl and protect the sink from scratches.

STANDARDS COMPLIANCE

This sink meets cUPC standards. The ST-05 strainer is cUPC certified by the factory.



Stylish International Inc.

www.stylishkb.com

[stylish.international.inc](https://www.instagram.com/stylish.international.inc)

care@stylishkb.com

+1-855-789-5352



KRYPTON S-131W

ÉVIER DE CUISINE À CUVE SIMPLE
FAIT MAIN EN ACIER INOXYDABLE



DIMENSIONS

31" x 19" x 9"

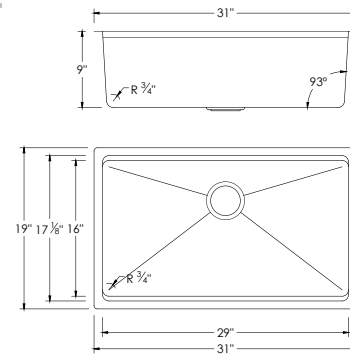

ACCESSOIRES INCLUS

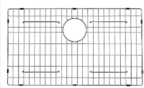

G-131
GRILLE



ST-05
CRÉPINE



A-06
ÉGOUTTOIR

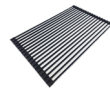

A-902BK
SÉCHOIR NOIR



A-917
PLANCHE À DÉCOUPER NOIR

ACCESSOIRES RECOMMANDÉS

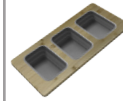

A-908



A-912
PLANCHE À DÉCOUPER

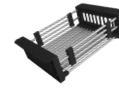

A-911
PANIER



A-916BK
TAPIS DE SÉCHAGE



S-01S
DISTRIBUTEUR DE SAVON

FINITION DE LA SURFACE

ACIER
INOXYDABLE
BROSSÉ

DIMENSION DE L'ORIFICE DU DRAIN



PROFILÉ D'ANGLE



RAYON 20mm

INSULATION

TAMPONS ENROBES
+
EN CAOUTCHOUC

PROFONDEUR DE LA CUVE



OPTIONS D'INSTALLATION

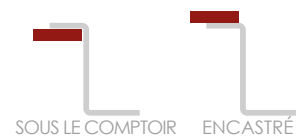

MATÉRIEL

Acier inoxydable de première qualité de calibre 16 avec teneur en chrome-nickel 18/10. La teneur en chrome de 18 % assure une durabilité, une protection maximale contre la rouille et une belle finition satinée.

La teneur en nickel de 10 % offre une excellente solidité et résistance.



DIMENSIONS DU PRODUIT

Dimensions Hors Tout	31" x 19" x 9"
Dimensions Intérieures	29" x 17 1/8" x 9"
Cuve Gauche	-
Cuve Droite	-
Taille d'ouverture du Drain	3 1/2"

CRÉPINES STANDARD

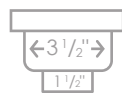

TAILLE DE L'ARMOIRE

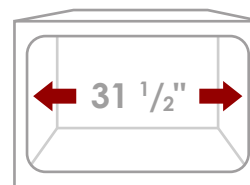

TAILLE MINIMALE
DE CAISSON INTERNE

ÉLIMINATION DES DÉCHETS

Les éviers Stylish® spossèdent une ouverture de siphon de 3 1/2" pouvant s'adapter à n'importe quel dispositif d'élimination des déchets. La structure de l'évier est bien conçue pour supporter tous les dispositifs d'élimination des déchets.



GARANTIE

Ce produit est couvert par une garantie à vie limitée. Consultez notre site internet pour obtenir tous les détails.

ENTRETIEN

Rincez et séchez votre évier avec un chiffon doux et propre, en veillant à frotter dans le sens du grain. Nous recommandons l'utilisation d'un doux mélange d'eau et de vinaigre pour éliminer les dépôts de minéraux qui peuvent éventuellement s'accumuler sur votre évier.

Utilisez des crèmes nettoyantes liquides non abrasives qui ne contiennent pas de chlore, d'hypochlorite de sodium ou d'acide chlorhydrique pour aider à conserver l'aspect original de votre évier. Assurez-vous de bien rincer votre évier et de l'essuyer. Nous recommandons l'utilisation d'une grille en acier inoxydable qui s'insère au fond de l'évier et le protège des rayures.



NORMES CONFORMES

Cet évier est conforme aux normes CUPC. La crépine ST-05 est certifiée CUPC par l'usine.

Stylish International Inc.

www.stylishkb.com

[stylish.international.inc](https://www.instagram.com/stylish.international.inc)

care@stylishkb.com

+1-855-789-5352